

# Smith Performance Sprayers Compression Sprayer

---

User Manual



**David Golf & Engineering Pty Ltd**

A.C.N 055 981 489 | A.B.N 85 260 948 796

Email: [dge@davidgolf.com.au](mailto:dge@davidgolf.com.au)

**Head Office Melbourne**

PO Box 330

OAKLEIGH VIC 3166

Ph: 03 9542 0222

Fax: 03 9540 0909

## **⚠ SAFETY PRECAUTIONS**

### **TEST SPRAYER WITH WATER BEFORE USING ANY CHEMICALS.**

- Read owner's manual completely before operating this sprayer.
- Always use goggles, gloves, and protective clothing when using sprayer.
- Read and follow all instructions and cautions on label of products used in this sprayer.
- Do not leave sprayer in the sun when not in use.
- Spray when air is calm to prevent drift of chemicals.
- Do not use sprayer near open flame or anything that could cause ignition of the spray.
- Always inspect hose and all hose connections before each use. A damaged hose, or loose hose connection can result in unintended exposure to the pressurized chemical, resulting in serious injury or property damage.
- Do not lift or carry sprayer by the hose, shut-off valve, or wand extension. Carry by the handle only.
- Do not pressurize with any mechanical device such as an air compressor, since this can create a dangerous pressure level and bursting of parts resulting in serious injury. Only use original pump.
- Do not store chemicals in this tank.
- Always release pressure when sprayer is not in use and before performing any maintenance.
- Clean and rinse sprayer thoroughly after each use.
- Never attempt to alter sprayer from original condition.
- Always use replacement parts from original manufacturer.
- Keep the sprayer and all chemicals out of the reach of children.
- Never fill with Hot liquids, max temp 30 degrees C or 85 degrees F

### **⚠ WARNING**

**ALWAYS CLEAN THE SPRAYER AND SHUT-OFF THOROUGHLY AFTER EACH USE OR WHEN CHANGING APPLICATIONS AS DESCRIBED IN THE CLEANING SECTION. FAILURE TO COMPLETELY CLEAN MAY CAUSE CROSS-CONTAMINATION.**

### **⚠ WARNING**

The sprayer is operated with liquid under pressure. Failure to observe caution and to follow instructions for operating and cleaning can cause tank, hose and other parts to be weakened and rupture under pressure. This can result in serious injury from high pressure discharge of liquids or forcible ejection of parts. Do not use flammable materials in this sprayer. Material could ignite or explode, causing serious injury and/or possible death. For safe use of this product, you must read and follow all instructions before use.

### **⚠ WARNING**

These Sprayers are designed to be used with harsh chemicals used in the industrial construction field. Use extreme caution when handling these materials and consult and follow all guidelines from the manufacturer for safety.

### **⚠ CAUTION**

Always empty, clean and dry tank, pump system, shut-off, hose, and extension after each use. FAILURE TO DO SO MAY WEAKEN SPRAYER COMPONENTS, CAUSING COMPONENTS TO RUPTURE WHEN PRESSURIZED. Additionally, FAILURE TO CLEAN AND PROPERLY MAINTAIN YOUR SPRAYER WILL VOID MANUFACTURER'S WARRANTY.

**Do not return sprayer to store, if you experience problems or have questions contact our toll free Customer Service Center, M-F 8A.M. - 5P.M., EST, at 1-800-311-9903, or e-mail: [Info@TheFGI.com](mailto:Info@TheFGI.com), or access online at: [www.TheFountainheadGroup.com](http://www.TheFountainheadGroup.com).**

## ASSEMBLY INSTRUCTIONS

### Assemble Hose To Tank

**IMPORTANT:** Do not attempt to heat or alter hose, hose nut, or barb prior to assembly.

1. Align hose barb tabs, push hose barb into tank until it stops (See Figure A).
2. Slide hose nut into place and turn clockwise to tighten. (See Figure B).

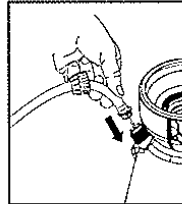


Figure A

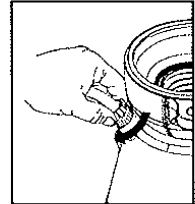
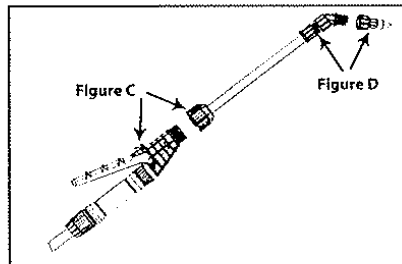


Figure B

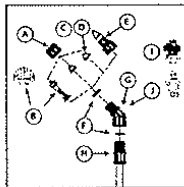
**NOTE:** Do not use tools to tighten hose nut.

### Assemble Extension, Shut-Off & Nozzle

1. Install the extension onto the shut-off assembly and tighten the nut securely. (See Figure C)
2. Install selected nozzle onto the end of the extension and tighten securely. (See Figure D)



**SELECT USING NOZZLE CHART BELOW**  
(Nozzle selections vary by model)



- A. Cap Nut
- B. Foaming Nozzle/High-Volume Foaming Nozzle
- C. Red High-Volume Fan Nozzle
- D. Yellow Low-Volume Fan Nozzle
- E. Adjustable Cone Nozzle
- F. Flat Seal
- G. Adapter
- H. Extension
- I. 4 Way Nozzle
- J. 3 Way Nozzle

<p><b>ADJUSTABLE CONE USES:</b></p> <ul style="list-style-type: none"> <li>• Spot spraying in or around flower beds, trees, and shrubs</li> <li>• Edging along fences, driveways, and walkways</li> <li>• Killing brush such as poison ivy, poison oak, kudzu and wild blackberry</li> <li>• Preparing garden beds for planting of ornamentals and vegetables</li> </ul>	<p><b>FOAMING NOZZLE USES:</b></p> <ul style="list-style-type: none"> <li>• Spot spraying in flower beds and lawns, driveways, and castles, around trees and shrubs.</li> <li>• Edging along fences, driveways and walkways.</li> <li>• Killing brush such as poison ivy, poison oak, kudzu and wild blackberry</li> </ul> <p>• High volume foam nozzle for cleaning applications.</p>
<p><b>RED HIGH VOLUME FAN NOZZLE USES:</b></p> <ul style="list-style-type: none"> <li>• Lawn replacement. Kill lawns and weeds before planting a new lawn</li> <li>• Preparing large areas for planting of ornamentals and vegetable gardens</li> </ul>	<p><b>YELLOW LOW VOLUME FAN NOZZLE USES:</b></p> <ul style="list-style-type: none"> <li>• For precision spraying in confined areas such as gardens and flower beds</li> </ul>
<p><b>4 WAY BRASS ADJUSTABLE NOZZLE USES:</b></p> <ul style="list-style-type: none"> <li>• For use where versatility is key. Nozzle for spraying in Pest Control applications in systems of fire, orange fans, grass &amp; weeds.</li> </ul>	<p><b>NON DRIP NOZZLE USES:</b></p> <ul style="list-style-type: none"> <li>• For spraying chemicals where any liquid that is not permitted. Perfect for areas that are sprayed where sensitive nearby.</li> </ul>
<p><b>3 WAY ADJUSTABLE NOZZLE USES:</b></p> <ul style="list-style-type: none"> <li>• For use where versatility and ease of use is key. Rotate to transition between stream, cone, and fan settings.</li> <li>• Spot spraying in or around flower beds, trees, and shrubs</li> <li>• Edging along fences, driveways, and walkways</li> <li>• Killing brush such as poison ivy, poison oak, kudzu and wild blackberry.</li> <li>• Preparing garden beds for planting of ornamentals and vegetables.</li> </ul>	

## OPERATING INSTRUCTIONS

### Filling

**IMPORTANT:** Always make sure the pressure is released from the tank before filling or servicing. If equipped, pull up on the knob of the pressure release valve until all the pressure is released from the tank. Otherwise, squeeze and hold shut-off lever until the unit stops spraying. Then, and only then, it is safe to remove pump.

1. Turn the pump handle counterclockwise to remove the pump (See Figure E).
2. Fill the tank to the desired level. See fill markings on side of tank. (Always refer to chemical manufacturer for proper mixture).
3. Install the pump into the tank opening and turn clockwise until tightly sealed against the tank (See Figure F).

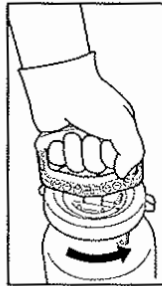


Figure E

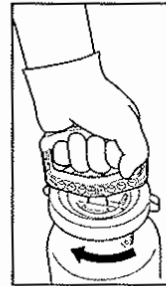


Figure F

### Pressurizing

1. Make sure shut-off lock is not engaged. (If shut-off lock is engaged while pressurizing, the unit will immediately start spraying).
2. Push down on the handle and turn counterclockwise to unlock the handle (See Figure G-1G).
3. Pressurize the sprayer by pumping the handle in a smooth up and down motion (See Figure G-2G).
4. Push down on the handle and turn clockwise to lock the handle into the pump (See Figure G-3G).

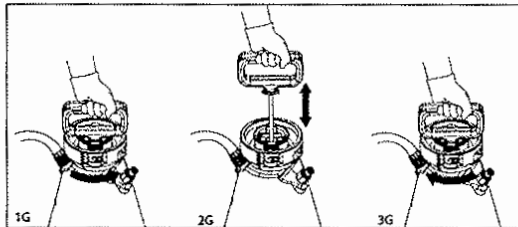


Figure G

### Spraying and Locking

1. Direct nozzle away from you and squeeze shut-off lever to begin spraying.
2. For continuous spraying, squeeze lever and rotate lock (See Figure H).
3. Unlock if needed and release shut-off lever to stop spraying.
4. Turn the nozzle tip to adjust the spray pattern.

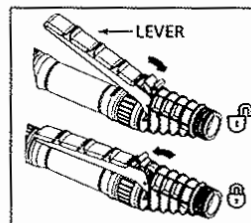


Figure H

### Release Tank Pressure

*Pressure Release Valve (PRV) on select models*

1. **NO PRV:** Lay the tank on its side with the hose outlet on the bottom. Direct the nozzle away from you and squeeze the shut-off lever until the unit stops spraying. (See Figure I)
2. **WITH PRV:** Pull up on the knob of the PRV until all pressure is released from the tank. (See Figure J)

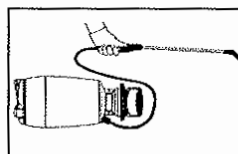


Figure I

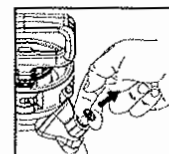


Figure J

## OPERATING INSTRUCTIONS CONTINUED

### Finish

1. Depressurize the tank as described in *Release Tank Pressure* section.
2. Turn the pump handle counterclockwise to remove the pump.
3. Empty any remaining liquid according to the product disposal directions.
4. Follow the *Cleaning* instructions.

### Cleaning

1. Remove the pump as described in the *Finish* section.
2. Fill the tank with cool, clean tap water. Replace the pump and tighten securely.
3. Agitate the tank to rinse the chemical from the tank wall and pump.
4. Remove the pump and empty the contents into gravel or bare soil.
5. Refill the tank with cool, clean tap water.
6. Make sure the pump is free of dirt or debris and reinstall into the tank. Tighten securely.
7. Pressurize the tank as described in the *Pressurizing* section.
8. Direct the nozzle away from you and activate the shut-off for at least 30 seconds to clean the hose and shut-off.
9. Release pressure as described in the *Release Tank Pressure* section.
10. Remove the pump and empty the contents into gravel or bare soil.
11. Repeat steps 5 - 10 until thoroughly cleaned.

### Sprayer Storage

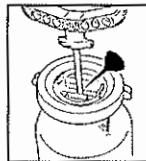
1. Sprayer tank should be hung upside down, with the pump removed.
2. Do not store or leave any solution in the tank after use.
3. Store in a warm, dry location out of direct sunlight.
4. **Keep the sprayer and all chemicals out of the reach of children.**

## MAINTENANCE

### Pump Lubrication

Pump should be periodically oiled by applying 10 to 12 drops of light oil down the pump rod through the opening in the pump cap as shown.

**NOTE: For the "R" Style Acetone Sprayer: Only a Silicone Based Oil should be used.**



"O" Style



"R" Style

### Pump Disassembly & Reassembly

**NOTE: Remove pump from tank prior to disassembly. As shown on varying models.**

#### "O" Style

1. Inspect gasket. If worn or damaged, remove and replace. (See Figure 1)
2. To disassemble pump cap from pump barrel, squeeze the tabs (See Figure 2) that lock the barrel to the cap, and while resting the extension clip on a table or bench turn the barrel counterclockwise to unlock. (See Figure 3)



Figure 1



Figure 2

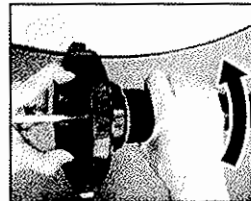
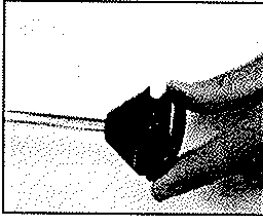


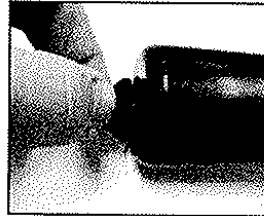
Figure 3

## MAINTENANCE CONTINUED

3. Inspect o-ring. If worn or damaged, remove and replace. Lubricate o-ring with petroleum jelly. (See Figure 4)
4. Inspect check valve in bottom of barrel. If worn or damaged, remove and replace by pressing into hole in bottom of barrel. (See Figure 5)
5. Re-install the barrel into the cap. While holding the cap securely, turn the barrel clockwise to lock the tabs in place.



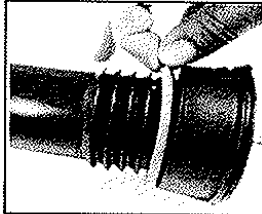
**Figure 4**



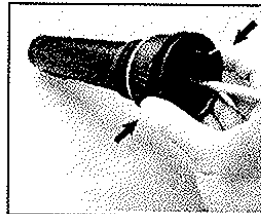
**Figure 5**

### "R" Style

1. Inspect gasket. If worn or damaged, remove and replace. (See Figure 6)
2. To remove pump cap from pump barrel, squeeze the tabs on the cap and pull away from barrel. (See Figure 7)

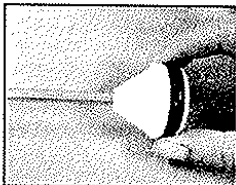


**Figure 6**

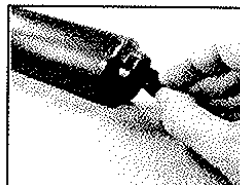


**Figure 7**

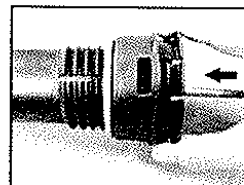
3. Inspect o-ring. If worn or damaged, remove and replace. For Acetone Sprayer lubricate o-ring with Silicone grease and for all others lubricate o-ring with petroleum jelly. (See Figure 8)
4. Inspect check valve in bottom of barrel. If worn or damaged, remove and replace by pressing into hole in bottom of barrel. (See Figure 9)
5. Insert the pump handle assembly into the barrel. Align the tabs of the pump cap with the rectangle cutouts on the barrel. Push cap into place until the cap snaps securely into position. (See Figure 10)



**Figure 8**



**Figure 9**



**Figure 10**

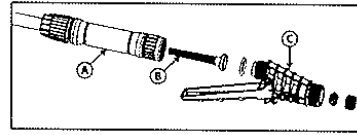
### **Nozzle Maintenance**

1. If nozzle clogs, remove and disassemble the nozzle assembly.
2. Clean the openings of any obstructions and reassemble.

### Shut-off Maintenance (Smith Pro II)

**Always depressurize sprayer before maintenance by activating shut-off and spraying contents out.**

1. Unscrew the handle from the shut-off assembly.
2. Remove the filter from the shut-off assembly.
3. Clean any debris from inside the handle, shut-off assembly, or the filter by rinsing with cool, clean water.
4. Reassemble the components as shown and tighten all connections securely.



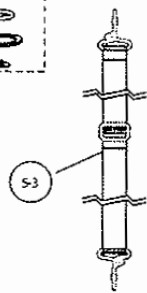
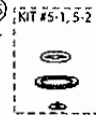
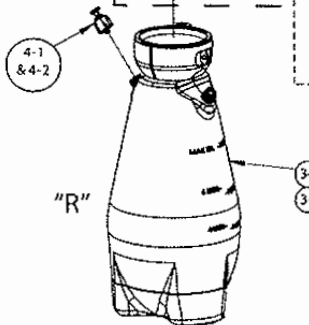
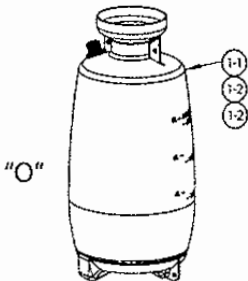
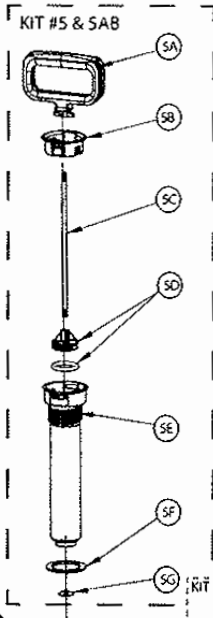
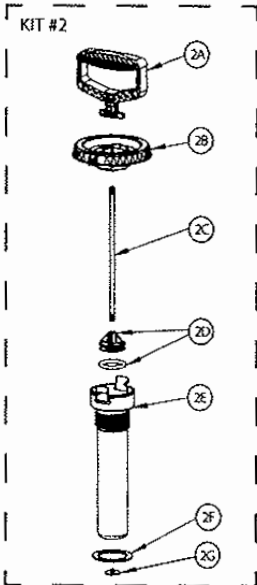
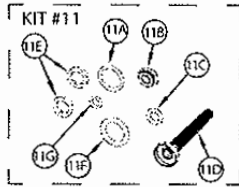
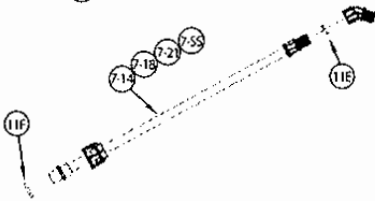
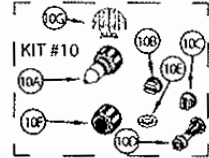
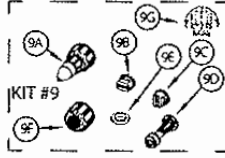
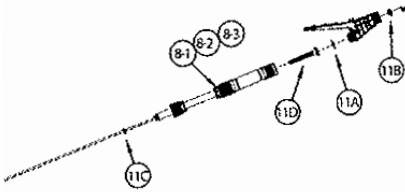
A. Handle  
B. Filter  
C. Shut-off Assembly

## TROUBLESHOOTING

TROUBLE	LOOK FOR	REMEDY
Sprayer starts to spray when pumping or sprayer will not stop spraying when shut-off lever is released.	Shut-off lock is engaged.	Squeeze shut-off lever and rotate the lock towards the nozzle as described in <i>Spraying and Locking</i> section.
Sprayer leaks at pump or sprayer does not build pressure.	<ol style="list-style-type: none"> <li>1. Dirt or debris on pump gasket (#2F or #5F) or closure.</li> <li>2. Chipped, torn, swollen, or defective pump gasket (#2F or #5F).</li> <li>3. Check valve (#2G or #5G) at bottom of pump assembly.</li> <li>4. Worn or damaged o-ring (#2D or #5D) on piston.</li> </ol>	<ol style="list-style-type: none"> <li>1. Clean dirt or debris from gasket (#2F or #5F) or closure.</li> <li>2. Remove old gasket (#2F or #5F) and replace with new as described in <i>Pump Disassembly &amp; Reassembly</i> section.</li> <li>3. Replace if missing or damaged as described in <i>Pump Disassembly &amp; Reassembly</i> section.</li> <li>4. Replace if worn or damaged as described in <i>Pump Disassembly &amp; Reassembly</i> section.</li> </ol>
Sprayer material overflows through pump barrel or pump handle rises when handle is unlocked.	<ol style="list-style-type: none"> <li>1. Dirt or debris under check valve (#2G or #5G) on pump.</li> <li>2. Chipped, torn, or swollen pump check valve (#2G or #5G).</li> </ol>	<ol style="list-style-type: none"> <li>1. Clean check valve (#2G or #5G) and valve sealing surface on pump.</li> <li>2. Replace check valve (#2G or #5G) as described in <i>Pump Disassembly &amp; Reassembly</i> section.</li> </ol>
Hose leaks at tank or shut-off.	<ol style="list-style-type: none"> <li>1. Loose hose.</li> <li>2. Cracked, swollen, or faulty hose.</li> </ol>	<ol style="list-style-type: none"> <li>1. Tighten hose nut.</li> <li>2. Replace shut-off assembly.</li> </ol>
Sprayer is difficult to pump.	<ol style="list-style-type: none"> <li>1. Damaged piston o-ring (#2D or #5D).</li> <li>2. Piston o-ring (#2D or #5D) is dry.</li> </ol>	<ol style="list-style-type: none"> <li>1. Replace piston o-ring as described in <i>Pump Disassembly &amp; Reassembly</i> section.</li> <li>2. Lubricate piston o-ring as described in <i>Pump Disassembly &amp; Reassembly</i> section.</li> </ol>
Sprayer tank leaks.	Evidence of spray material escaping from the tank.	Replace entire sprayer.
Nozzle drips when shut-off lever is released.	<ol style="list-style-type: none"> <li>1. Dirt or debris in shut-off valve.</li> <li>2. Damaged o-ring or seal in shut-off (kit #11).</li> </ol>	<ol style="list-style-type: none"> <li>1. Clean shut-off as described in <i>Shut-off Maintenance</i> section.</li> <li>2. Service shut-off seals as described in <i>Maintenance service kit #11</i>.</li> </ol>
Nozzle tip leaks, poor spray pattern, partial spray or complete stoppage.	<ol style="list-style-type: none"> <li>1. Flat seal is missing or damaged.</li> <li>2. Spray extension or nozzle clogged.</li> </ol>	<ol style="list-style-type: none"> <li>1. Replace flat seal at extension tip (kit #11).</li> <li>2. Remove nozzle and clean as described in <i>Nozzle Maintenance</i> section.</li> </ol>



KITS, PARTS & ACCESSORIES



## "O" SPRAYER PARTS

KEY#	PART#	DESCRIPTION
-2	181036	2 GALLON "O" TANK
1 -3	181120	3 GALLON "O" TANK

### KIT #2 180398 "O" PUMP

2A	180279	"O" PUMP HANDLE
2B	178040	"O" PUMP CAP
2C	180278	"O" PUMP ROD
2D	180429	"O" PUMP PISTON ASSEMBLY
2E	178041	"O" PUMP BARREL
2F	178039V	"O" PUMP GASKET, VITON
2G	171015V	CHECK VALVE, VITON

## "R" SPRAYER PARTS

KEY#	PART#	DESCRIPTION
-2	182264	2 GALLON "R" TANK (INCLUDES KEY #4)
3 -3	182265	3 GALLON "R" TANK (INCLUDES KEY #4)
-1	182495	VITON PRV ASSEMBLY
4 -2	182500	EPDM PRV ASSEMBLY

### KIT #5 182413 "R" PUMP Viton

5A	182257	"R" PUMP HANDLE
5B	182219	PUMP CAP
5C	180278	"O" PUMP ROD
5D	180429	VITON PUMP PISTON ASSEMBLY
5E	182220	UNIVERSAL PUMP BARREL
5F	178039V	"R" PUMP GASKET
5G	171015V	CHECK VALVE, VITON

### KIT #5AB 182528 "R" PUMP EPDM SEALS AND GASKETS FOR ACETONE SPRAYER - #190450

### KIT #5-1 182675 VITON PUMP SERVICE KIT

### KIT #5-2 182676 EPDM PUMP SERVICE KIT

### KIT #5-3 181080 SHOULDER CARRYING STRAP

## SMITH PERFORMANCE SHUT-OFF AND WAND KITS

KEY#	PART#	DESCRIPTION
7	-14	181845 14" EXTENSION ASSEMBLY
	-18	181843 18" EXTENSION ASSEMBLY
	-21	181824 21" EXTENSION ASSEMBLY
	-SS	182112 21" EXTENSION ASSEMBLY, STAINLESS STEEL
8	-1	181818 SHUT-OFF ASSEMBLY WITH HOSE AND DIP TUBE 2 GAL
	-2	181819 SHUT-OFF ASSEMBLY WITH HOSE AND DIP TUBE 3 GAL
	-3	182491 SHUT-OFF ASSEMBLY, ACID SPRAYER
	-4	182187 HIGH VOLUME FOAMING NOZZLE

### KIT #9 182619 POLY NOZZLE KIT

9A	181822	POLY ADJUSTABLE NOZZLE
9B	180168	YELLOW FLAT FAN NOZZLE (LOW VOLUME)
9C	180097	RED FLAT FAN NOZZLE (HIGH VOLUME)
9D	180266	FOAMING NOZZLE
9E	181812	FLAT NOZZLE SEAL
9F	181804	NOZZLE CAP NUT
9G	182187	HIGH VOLUME FOAMING NOZZLE

### KIT #10 182620 BRASS NOZZLE KIT

10A	181823	BRASS ADJUSTABLE NOZZLE
10B	180168	YELLOW FLAT FAN NOZZLE (LOW VOLUME)
10C	180097	RED FLAT FAN NOZZLE (HIGH VOLUME)
10D	180266	FOAMING NOZZLE
10E	181812	FLAT NOZZLE SEAL
10F	181804	NOZZLE CAP NUT
10G	182187	HIGH VOLUME FOAMING NOZZLE

### KIT #11 181910 SMITH PERFORMANCE POLY SHUT-OFF SERVICE KIT

11A	181493	VALVE BODY O-RING
11B	181840	POPPET SEAL
11C	181231	BARB O-RING
11D	181468	FILTER
11E	181812	FLAT NOZZLE SEAL (2)
11F	181810	WAND O-RING
11G	181805	ADJUSTABLE NOZZLE O-RING

### KIT #11-1 182672 SMITH PERFORMANCE SHUT-OFF AND WAND REPLACEMENT KIT (STAINLESS WAND)

182112	21" EXTENSION ASSEMBLY, STAINLESS STEEL
181941	SMITH PERFORMANCE POLY VITON SHUT-OFF
181804	NOZZLE CAP NUT

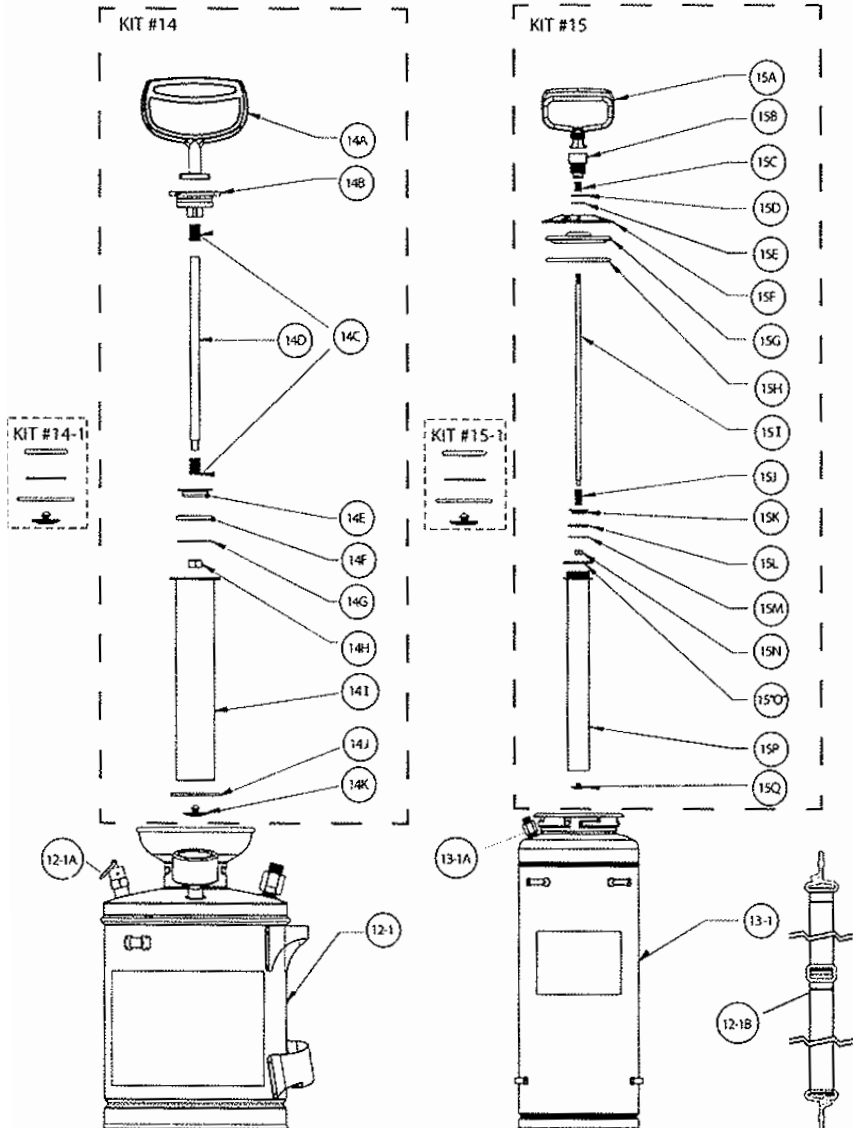
### KIT #11-2 182673 SMITH PERFORMANCE SHUT-OFF AND WAND REPLACEMENT KIT

181824	21" EXTENSION ASSEMBLY, POLY
181941	SMITH PERFORMANCE POLY VITON SHUT-OFF
181804	NOZZLE CAP NUT

### KIT #11-3 182674 SMITH PERFORMANCE SHUT-OFF AND WAND REPLACEMENT KIT (ACID SPRAYER - #190449)

181824	21" EXTENSION ASSEMBLY, POLY
182649	SMITH PERFORMANCE POLY VITON SHUT-OFF FOR ACID SPRAYER - #190449
181804	NOZZLE CAP NUT

**KITS, PARTS & ACCESSORIES**



KEY#	PART#	DESCRIPTION
12-1	182490	1 GALLON STAINLESS STEEL TANK
12-1A	182678	PRESSURE RELIEF VALVE FOR 1 GALLON STAINLESS STEEL TANK
12-1B	182677	SHOULDER STRAP FOR 1 OR 3.5 GALLON STAINLESS STEEL TANK
13-1	182521	3.5 GALLON STAINLESS STEEL TANK WITH PRESSURE RELIEF VALVE
13-1A	182679	PRESSURE RELIEF VALVE FOR 3.5 GALLON STAINLESS STEEL TANK

**KIT #14 182534 PUMP**

KEY	DESCRIPTION
14A	PUMP HANDLE
14B	PUMP LID
14C	SPRING_670 X 048
14D	PISTON POLE
14E	VALVE SEAT
14F	O-RING 30mm X 4mm, V
14G	SHEET
14H	LOCKNUT
14I	AIR PUMP
14J	FLAT WASHER, 1 GAL SS, V
14K	CHECK VALVE

**KIT #14-1 182643 PUMP SEAL AND GASKET  
REPAIR KIT FOR #182534**

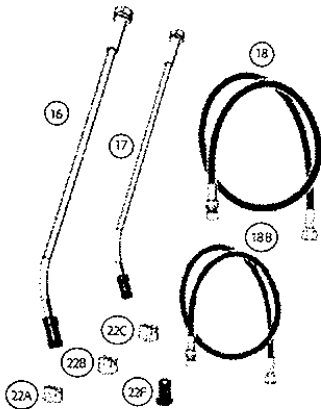
**KIT #15 182522 PUMP**

KEY	DESCRIPTION
15A	PUMP HANDLE
15B	PRESS BUTTON
15C	SPRING_670 X 048
15D	FLAT WASHER
15E	RETAINING RING
15F	CLAMP, COVER
15G	GAS LID
15H	O-RING 105mm X 5.7mm
15I	PISTON POLE
15J	SPRING_1 X 048
15K	VALVE SEAT
15L	O-RING 30mm X 4mm, V
15M	SHEET
15N	NYLON-INSERT HEX LOCKNUT
15"O"	O-RING 46mm X 3.5mm, V
15P	AIR PUMP
15Q	CHECK VALVE, PUMP, V

**KIT #15-1 182644 PUMP SEAL AND GASKET  
REPAIR KIT FOR #182522**

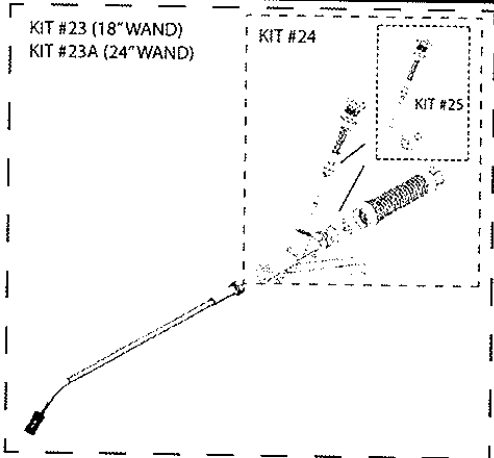
**KITS, PARTS & ACCESSORIES**

**"XL" Shut-Off and Wand**



KIT #23 (18" WAND)  
KIT #23A (24" WAND)

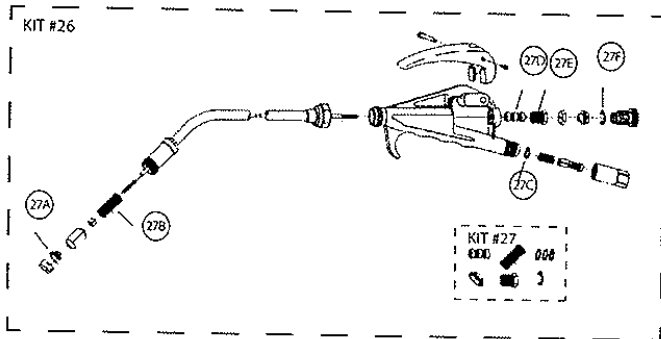
KIT #24



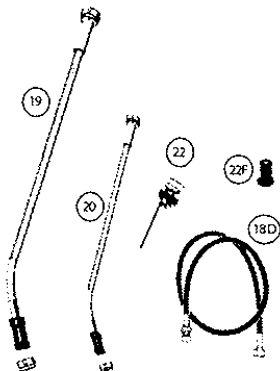
**"XB" Shut-Off and Wand**



KIT #26

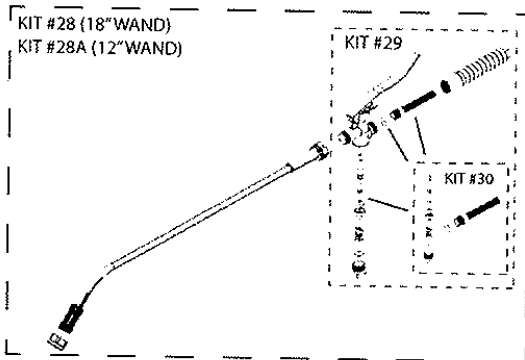


**"ZL" Shut-Off and Wand**



KIT #28 (18" WAND)  
KIT #28A (12" WAND)

KIT #29



KEY#	PART#	DESCRIPTION
16	182661	24" BRASS WAND ASSEMBLY FOR XL SHUT-OFF
17	182565	18" BRASS WAND ASSEMBLY FOR XL SHUT-OFF
18	182571	50" HOSE ASSEMBLY FOR CONCRETE SPRAYER #190448
18B	182629	50" HOSE ASSEMBLY FOR POLY CONCRETE SPRAYER - #190450
18C	182507	50" EPDM HOSE FOR ACETONE SPRAYER - #190451
18D	182570	50" HOSE FOR PEST CONTROL SPRAYER - #190441
19	182464	18" SS WAND ASSEMBLY FOR ZL SHUT-OFF
20	182639	12" SS WAND ASSEMBLY FOR ZL SHUT-OFF
21	182567	BRASS ADJUSTABLE NOZZLE FOR XL, XB, & ZL SHUT-OFF
22	182379	4-WAY ADJUSTABLE NOZZLE

**KIT #23 182634 XL SHUT-OFF & WAND ASSEMBLY**

KIT #24	XL SHUT-OFF ASSEMBLY
17	18" BRASS WAND ASSEMBLY FOR XL SHUT-OFF

**KIT #23A 182635 XL SHUT-OFF & WAND ASSEMBLY**

KIT #24	XL SHUT-OFF ASSEMBLY
16	24" BRASS WAND ASSEMBLY FOR XL SHUT-OFF

**KIT #24 182563 COMPLETE XL SHUT-OFF ASSEMBLY**

**KIT #25 182568 XL SHUT-OFF REPAIR KIT**

25A	VALVE STEM SUB-ASSEMBLY
25B	BRASS GUIDE
25C	O-RING #1
25D	GASKET, COPPER
25E	VALVE SPRING
25F	VITON O-RING
25G	FLAT GASKET
25H	VALVE CAP

**KIT #26 182663 COMPLETE XB SHUT-OFF ASSEMBLY**

**KIT #27 182569 XB SHUT-OFF REPAIR KIT**

27A	GASKET, SOFT SEAT
27B	SPRING, SEAT STEM
27C	GASKET, NYLON (3)
27D	PACKING, VALVE (3)
27E	NUT, PACKING
27F	RING, SNAP

KEY#	PART#	DESCRIPTION
22A	176042	BRASS FLAT SPRAY NOZZLE, .2 GPM @ 40 PSI, 80° SPRAY PATTERN.
22B	176171	BRASS FLAT SPRAY NOZZLE, .5 GPM @ 40PSI, 80° SPRAY PATTERN.
22C	182577	BRASS FLAT SPRAY NOZZLE, .5 GPM @ 40 PSI, 95° SPRAY PATTERN.
22D	176116	BRASS FLAT SPRAY NOZZLE, .5 GPM @ 40 PSI, 80° SPRAY PATTERN
22E	182578	BRASS FLAT SPRAY NOZZLE, .5 GPM @ 40 PSI, 65° SPRAY PATTERN.
22F	176332	CHECK VALVE STRAINER

**KIT #28 182636 COMPLETE ZL SHUT-OFF & WAND ASSEMBLY**

KIT #29	ZL SHUT-OFF ASSEMBLY
19	18" STAINLESS STEEL WAND FOR ZL SHUT-OFF

**KIT #28A 182652 COMPLETE ZL SHUT-OFF & WAND ASSEMBLY**

KIT #29	ZL SHUT-OFF ASSEMBLY
20	12" STAINLESS STEEL WAND FOR ZL SHUT-OFF

**KIT #29 182465 COMPLETE ZL SHUT-OFF ASSEMBLY**

**KIT #30 182621 ZL SHUT-OFF REPAIR KIT**

30A	ORING, SS SHUT-OFF VALVE, V (QTY 2)
30B	CAP, SS SHUT-OFF VALVE BODY
30C	SPRING, SS SHUT-OFF VALVE
30D	BASE, SS SHUT-OFF VALVE
30E	STEM, SS SHUT-OFF VALVE
30F	SEAL, SS SHUT-OFF VALVE, V
30G	O-RING, SS SHUT-OFF VALVE, V
30H	FILTER, SS SHUT-OFF